

# MN39260FH

## 4.5 mm (type-1/4) 810k-pixel CCD Area Image Sensor

### ■ Overview

The MN39260FH is a 4.5 mm (type-1/4) interline transfer CCD (IT-CCD) solid state image sensor device.

This device uses photodiodes in the optoelectric conversion section and CCDs for signal readout. The electronic shutter function has made an exposure time of 1/10000 seconds possible. Further, this device has the features of high sensitivity, low noise, broad dynamic range, and low smear.

This device has a total of 802 579 pixels (1 007 horizontal × 797 vertical) and provides stable and clear images with a resolution of 600 horizontal TV-lines and 420 vertical TV-lines.

Part Number	Size	System	Color or B/W
MN39260FH	4.5 mm (type-1/4)	PAL	Color

### ■ Features

- Effective pixel number 962 (horizontal) × 774 (vertical)
- High sensitivity
- Broad dynamic range
- Low smear
- Electronic shutter

### ■ Applications

- Camcorders
- FA, OA cameras

### ■ Pin Assignments

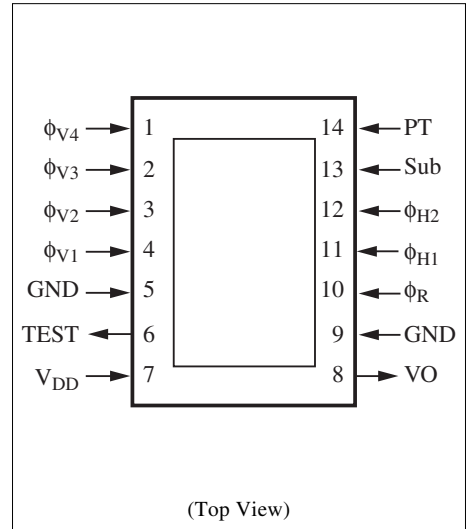

■ Block Diagram

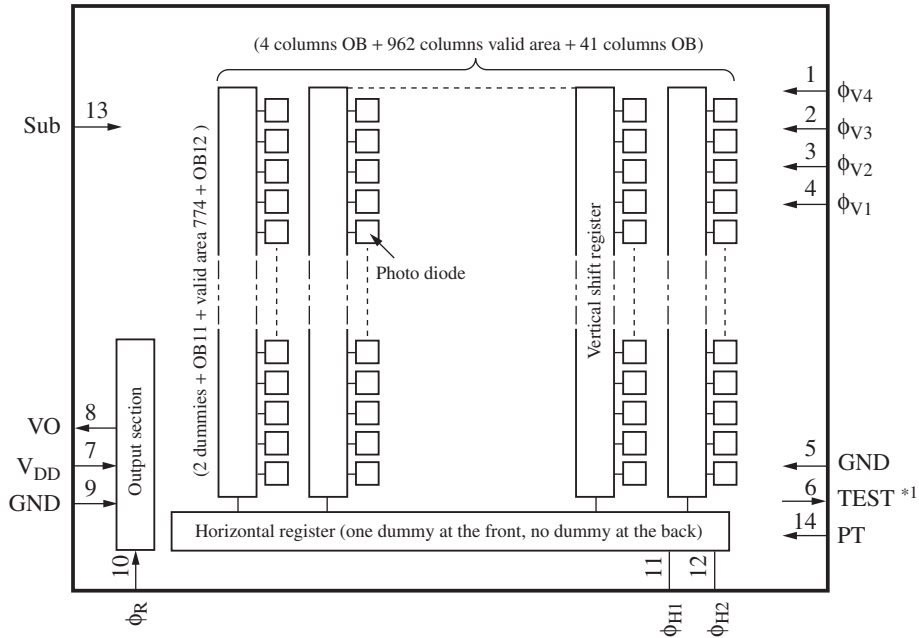

\*1 : TEST pin must be left open, because the pin outputs CCD internal bias voltage.

■ Pin Descriptions

Pin No.	Symbol	Description	Pin No.	Symbol	Description
1	$\phi_{V4}$	Vertical shift register clock pulse 4	8	VO	Video output
2	$\phi_{V3}$	Vertical shift register clock pulse 3	9	GND	GND
3	$\phi_{V2}$	Vertical shift register clock pulse 2	10	$\phi_R$	Reset pulse (RG)
4	$\phi_{V1}$	Vertical shift register clock pulse 1	11	$\phi_{H1}$	Horizontal register clock pulse 1
5	GND	GND	12	$\phi_{H2}$	Horizontal register clock pulse 2
6	TEST	TEST pin (OPEN) *1	13	Sub	Substrate
7	$V_{DD}$	Power supply	14	PT	P-well for protection circuit

Note) \*1: TEST pin must be left open, because the pin outputs CCD internal bias voltage.

■ Device Parameter (H × V)

Parameter	Value	Unit
Pixel number *1	962 × 774	pixel
Image sensing block dimension	3.7037 × 2.7090	mm <sup>2</sup>
Pixel dimension	3.85 × 3.50	μm <sup>2</sup>

Note) \*1: OB columns are not included.

### ■ Absolute Maximum Ratings and Operating Conditions

Parameter		Absolute maximum rating		Operating condition			Unit
		Lower limit	Upper limit	Min	Typ	Max	
$V_{DD}$		-0.2	18	14.5	15.0	15.5	V
$V_{PT}^{*3,4}$		-10.0	0.2	-7.5	-7.0	-6.5	V
GND		(Reference voltage)		—	0	—	V
$V_{\phi R}$	High-Low	—	8	3.0	3.3	3.6	V
	Bias	(Supplied internally)					V
$V_{\phi H1}$	High	—	8	3.0	3.3	3.6	V
	Low	-0.2	—	-0.2	0	0.2	V
$V_{\phi H2}$	High	—	8	3.0	3.3	3.6	V
	Low	-0.2	—	-0.2	0	0.2	V
$V_{Sub}^{*2}$		(Supplied internally)					V
$\phi V_{Sub}^{*1}$		-0.2	35	21.0	22.0	23.0	V
$V_{\phi V1}^{*3,4}$	High	—	18	14.5	15.0	15.5	V
	Middle	—	—	-0.05	0	0.05	V
	Low	-9	—	-7.5	-7.0	-6.5	V
$V_{\phi V2}^{*3,4}$	Middle	—	15	-0.05	0	0.05	V
	Low	-9	—	-7.5	-7.0	-6.5	V
$V_{\phi V3}^{*3,4}$	High	—	18	14.5	15.0	15.5	V
	Middle	—	—	-0.05	0	0.05	V
	Low	-9	—	-7.5	-7.0	-6.5	V
$V_{\phi V4}^{*3,4}$	Middle	—	15	-0.05	0	0.05	V
	Low	-9	—	-7.5	-7.0	-6.5	V
Operating temperature		-10	60	—	25	—	°C
Storage temperature		-30	80	—	—	—	°C

■ Absolute Maximum Ratings and Operating Conditions (continued)

Note) 1. Standard photo detecting condition

Standard photo detecting condition stands for detecting image with a light source of color temperature of 2856K, luminance of 1050 cd/m<sup>2</sup>, and using a color temperature conversion filter LB-40 (HOYA), infrared cut filter CAW-500S with thickness 2.5 mm for a light path and with F8 lens aperture. The quantity of the incidental light to a photo-detecting surface under the above condition is defined as the standard quantity of light.

2. \*1:  $V_{Sub}$  when using electronic shutter function

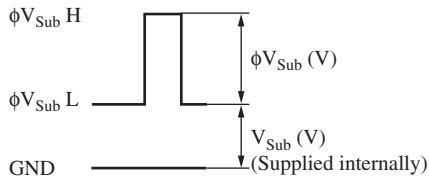

\*  $\phi Sub$  pulse generates once every 1 V period.

\*2:  $V_{Sub}$  supplied internally is the voltage suppressing the blooming generation at  $\times 500$  light quantity relative to the standard light quantity.

\*3: Relation between  $V_{PT}$  and  $V_{\phi VL}$

Set  $V_{PT}$  under the following condition against VL of a vertical transfer clock waveform.

$$V_{PT} \leq VL \text{ (} V_{\phi V1L} \text{ to } V_{\phi V4L} \text{)}$$

\*4: Absolute maximum ratings  $-0.2 < V_{\phi V} - V_{PT} < 24.5 \text{ (V)}$

■ Optical Characteristics

Parameter	Symbol	Conditions	Min	Typ	Max	Unit
Carrier saturation output	Sc	J chart	500	—	—	mV
Sensitivity	So	J chart F1.4, 1/32 ND	80	110	—	mV
Vertical smear	Sm	1/10 V chart, F1.4	—	—	0.01	%

Note) The above-mentioned characteristics are the values on driving the device for the imaging stabilizer mode (1/60 seconds accumulation).

■ Timing Diagram

- High speed pulse timing

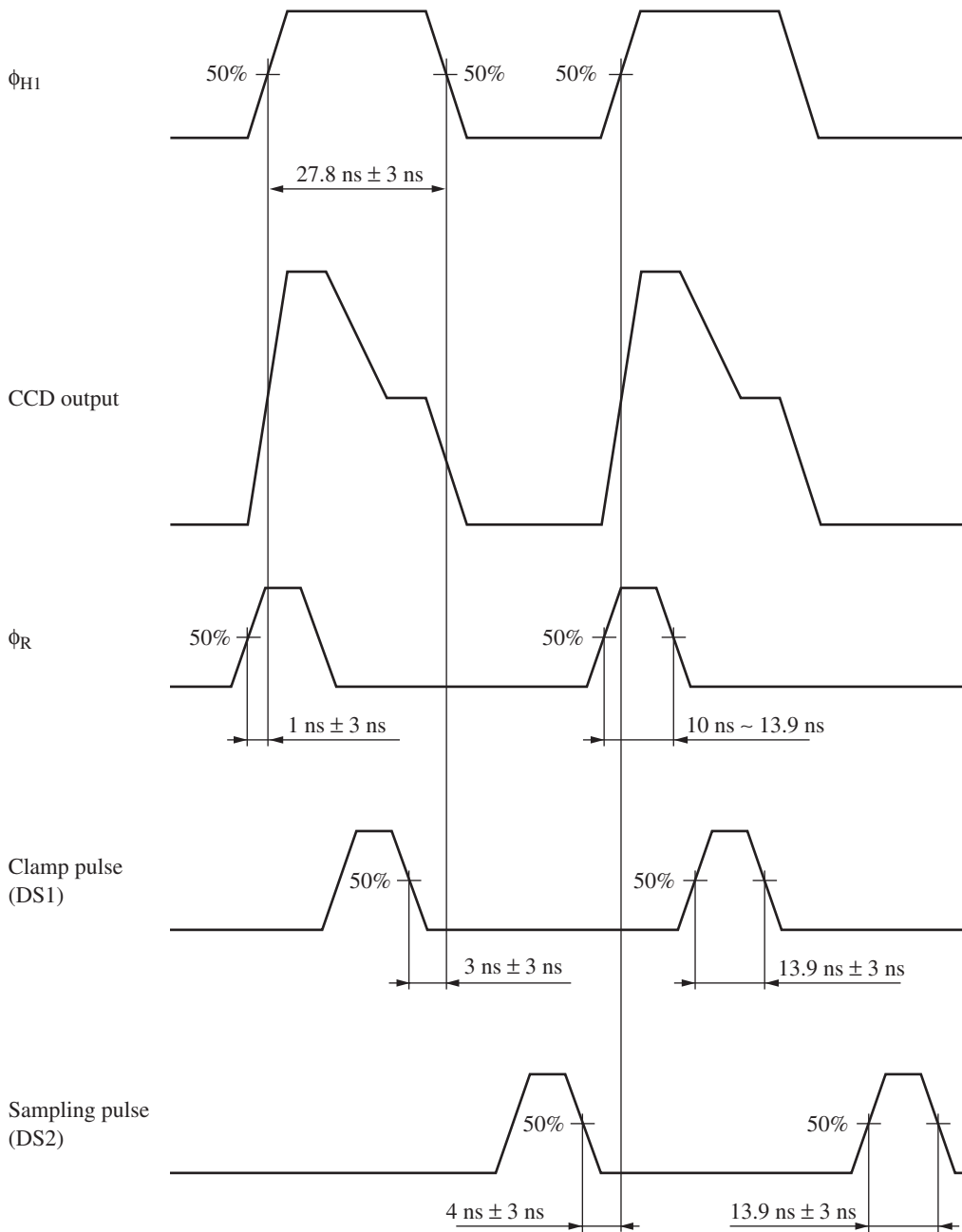

■ Timing Diagram (continued)

- Rise time and fall time of each pulse

$\phi_{V1}, \phi_{V3}$

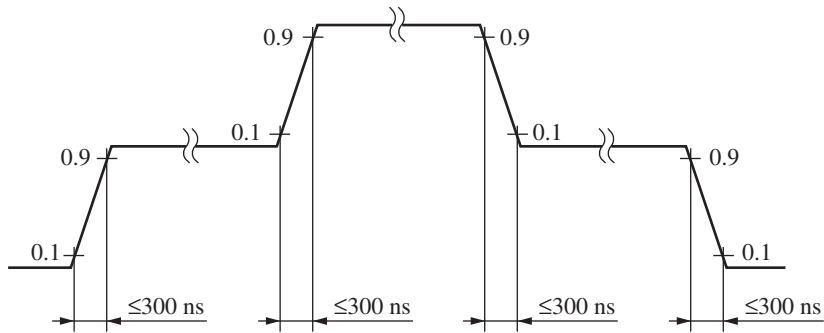

$\phi_{V2}, \phi_{V4}$

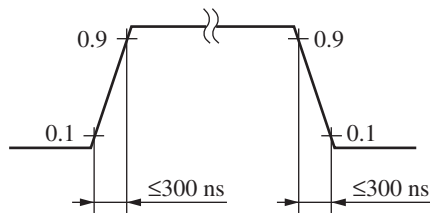

$\phi_{H1}, \phi_{H2}$

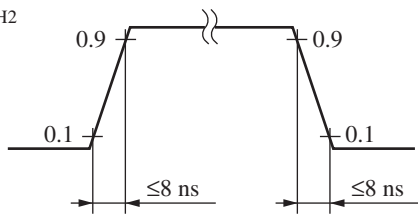

$\phi_R$

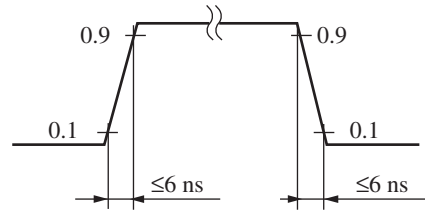

■ Color Filter Arrays on CCD

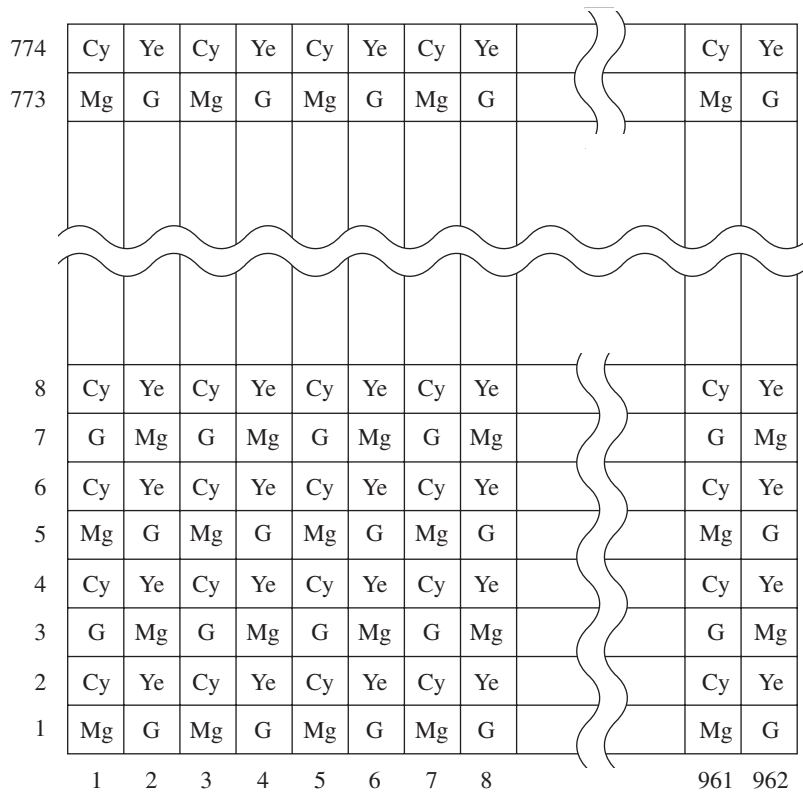

■ Graph of Characteristics

CCD color filter spectral characteristics

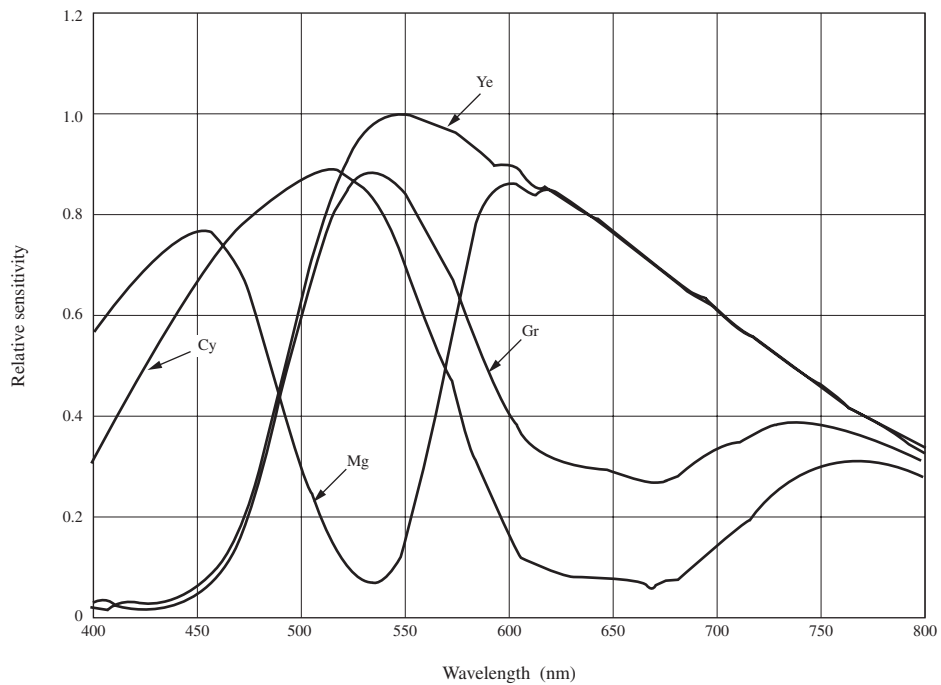





## Request for your special attention and precautions in using the technical information and semiconductors described in this material

- (1) An export permit needs to be obtained from the competent authorities of the Japanese Government if any of the products or technologies described in this material and controlled under the "Foreign Exchange and Foreign Trade Law" is to be exported or taken out of Japan.
- (2) The technical information described in this material is limited to showing representative characteristics and applied circuit examples of the products. It does not constitute the warranting of industrial property, the granting of relative rights, or the granting of any license.
- (3) The products described in this material are intended to be used for standard applications or general electronic equipment (such as office equipment, communications equipment, measuring instruments and household appliances).  
Consult our sales staff in advance for information on the following applications:
  - Special applications (such as for airplanes, aerospace, automobiles, traffic control equipment, combustion equipment, life support systems and safety devices) in which exceptional quality and reliability are required, or if the failure or malfunction of the products may directly jeopardize life or harm the human body.
  - Any applications other than the standard applications intended.
- (4) The products and product specifications described in this material are subject to change without notice for reasons of modification and/or improvement. At the final stage of your design, purchasing, or use of the products, therefore, ask for the most up-to-date Product Standards in advance to make sure that the latest specifications satisfy your requirements.
- (5) When designing your equipment, comply with the guaranteed values, in particular those of maximum rating, the range of operating power supply voltage and heat radiation characteristics. Otherwise, we will not be liable for any defect which may arise later in your equipment.  
Even when the products are used within the guaranteed values, redundant design is recommended, so that such equipment may not violate relevant laws or regulations because of the function of our products.
- (6) When using products for which dry packing is required, observe the conditions (including shelf life and after-unpacking standby time) agreed upon when specification sheets are individually exchanged.
- (7) No part of this material may be reprinted or reproduced by any means without written permission from our company.

## Please read the following notes before using the datasheets

- A. These materials are intended as a reference to assist customers with the selection of Panasonic semiconductor products best suited to their applications.  
Due to modification or other reasons, any information contained in this material, such as available product types, technical data, and so on, is subject to change without notice.  
Customers are advised to contact our semiconductor sales office and obtain the latest information before starting precise technical research and/or purchasing activities.
- B. Panasonic is endeavoring to continually improve the quality and reliability of these materials but there is always the possibility that further rectifications will be required in the future. Therefore, Panasonic will not assume any liability for any damages arising from any errors etc. that may appear in this material.
- C. These materials are solely intended for a customer's individual use.  
Therefore, without the prior written approval of Panasonic, any other use such as reproducing, selling, or distributing this material to a third party, via the Internet or in any other way, is prohibited.